

SPRINGTEC SUPER T47







Gama diseñada para la suspensión de falsos techos acústicos y maquinaria trabajando a partir de 450 r.p.m. Fabricado con muelle calidad cola de piano de gran resistencia mecánica, guiado por dos placas de caucho y con tope fin de carrera interior para evitar la posibilidad de contacto entre espiras, en caso de sobrecarga.

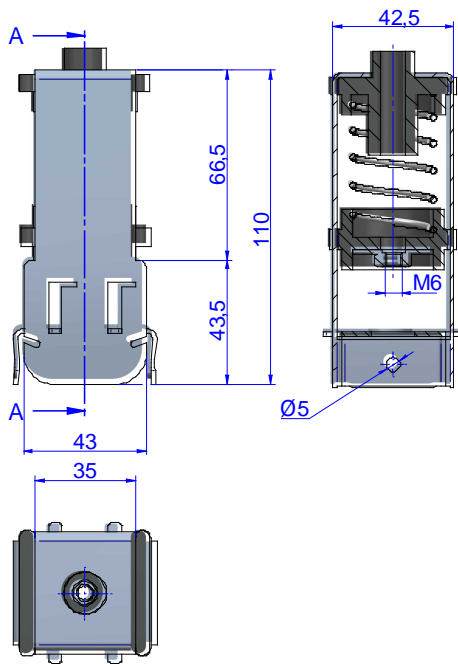

PLANOS



DIMENSIONES

	Tipo	CARGA MAX. PERMANENTE	Peso (kg)	Código
	Springtec Super T-47 Tipo ST-5	5	0,197	23426
	Springtec Super T-47 Tipo ST-10	10	0,197	23421
	Springtec Super T-47 Tipo ST-20	20	0,21	23422
	Springtec Super T-47 Tipo ST-30	30	0,23	23423
	Springtec Super T-47 Tipo ST-60	60	0,24	23424

Propiedades elásticas

NATURAL FREQUENCY
 AMC MECANOCAUCHO SPRINGTEC

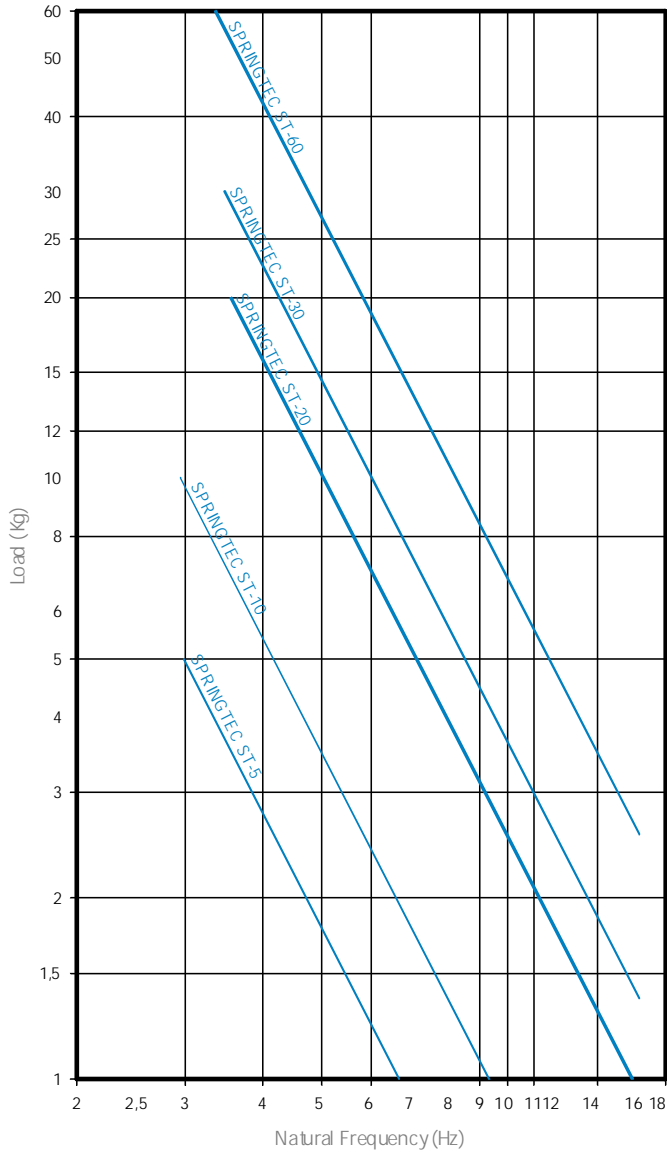

LOAD DEFLECTION GRAPH
 AMC MECANOCAUCHO SPRINGTEC

