

SPRINGTEC SUPER T60







Gama diseñada para la suspensión de falsos techos acústicos y maquinaria trabajando a partir de 450 r.p.m. Fabricado con muelle calidad cola de piano de gran resistencia mecánica, guiado por dos placas de caucho y con tope fin de carrera interior para evitar la posibilidad de contacto entre espiras, en caso de sobrecarga.

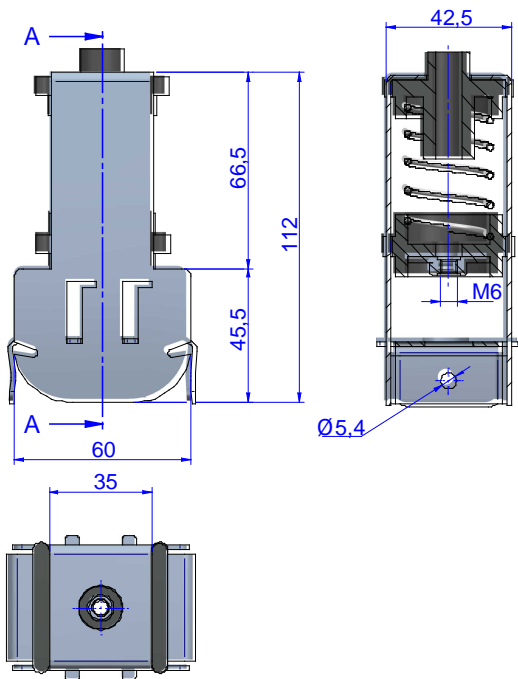

PLANOS



DIMENSIONES

	Tipo	CARGA MÁX. PERMANENTE	Peso (kg)	Código
	Springtec Super T-60 Tipo ST-5	5	0,242	23427
	Springtec Super T-60 Tipo ST-10	10	0,242	23351
	Springtec Super T-60 Tipo ST-20	20	0,242	23352
	Springtec Super T-60 Tipo ST-30	30	0,236	23353
	Springtec Super T-60 Tipo ST-60	60	0,264	23354

Propiedades elásticas

NATURAL FREQUENCY
 AMC MECANOCAUCHO SPRINGTEC

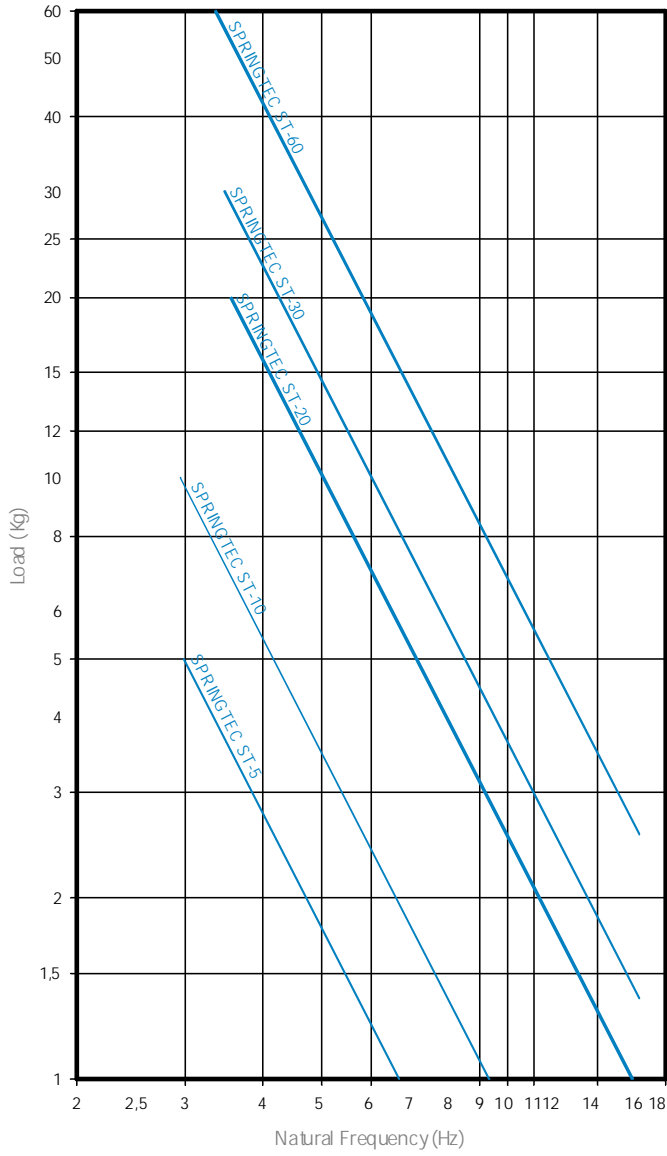

LOAD DEFLECTION GRAPH
 AMC MECANOCAUCHO SPRINGTEC

